

# PTF 10154

## 85 Watts, 1.93–1.99 GHz

### GOLDMOS<sup>®</sup> Field Effect Transistor

#### Description

The PTF 10154 is an internally matched 85-watt GOLDMOS FET intended for CDMA and TDMA applications from 1.93 to 1.99 GHz. This device operates at 43% efficiency with 11 dB gain. Nitride surface passivation and full gold metallization ensure excellent device life-time and reliability.

- **INTERNALLY MATCHED**
- **Guaranteed Performance at 1.93, 1.99 GHz, 28 V**
  - Output Power = 85 Watts Min
  - Power Gain = 11 dB Typ
- **Full Gold Metallization**
- **Silicon Nitride Passivated**
- **Back Side Common Source**
- **Excellent Thermal Stability**
- **100% Lot Traceability**

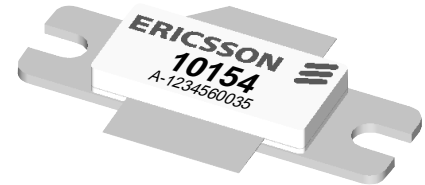
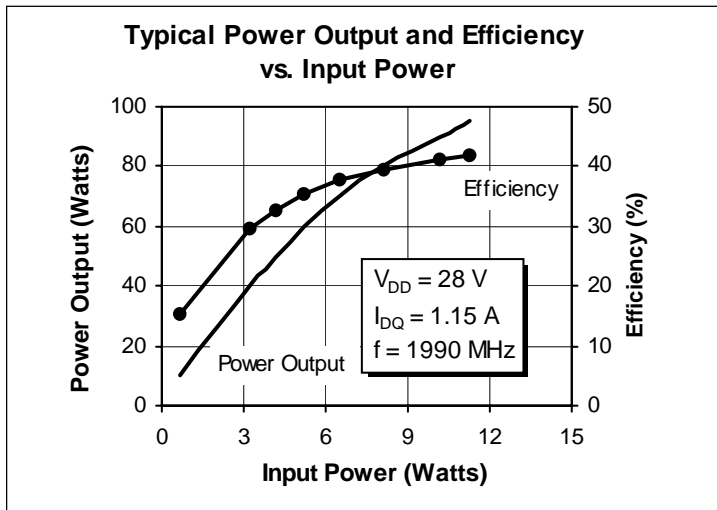

Package 20248

#### RF Specifications (100% Tested)

Characteristic	Symbol	Min	Typ	Max	Units
<b>Gain</b> ( $V_{DD} = 28\text{ V}$ , $P_{OUT} = 10\text{ W}$ , $I_{DQ} = 1.15\text{ A}$ , $f = 1.96, 1.99\text{ GHz}$ )	$G_{ps}$	10.0	11	—	dB
<b>Power Output at 1 dB Compression</b> ( $V_{DD} = 28\text{ V}$ , $I_{DQ} = 1.15\text{ A}$ , $f = 1.99\text{ GHz}$ )	P-1dB	85	—	—	Watts
<b>Drain Efficiency</b> ( $V_{DD} = 28\text{ V}$ , $P_{OUT} = 90\text{ W}$ , $I_{DQ} = 1.15\text{ A}$ , $f = 1.99\text{ GHz}$ )	$\eta_D$	—	43	—	%
<b>Load Mismatch Tolerance</b> ( $V_{DD} = 28\text{ V}$ , $P_{OUT} = 90\text{ W}$ , $I_{DQ} = 1.15\text{ A}$ , $f = 1.99\text{ GHz}$ —all phase angles at frequency of test)	$\Psi$	—	—	10:1	—

All published data at  $T_{CASE} = 25^\circ\text{C}$  unless otherwise indicated.

## Electrical Characteristics (100% Tested)

Characteristic	Conditions	Symbol	Min	Typ	Max	Units
Drain-Source Breakdown Voltage	$V_{GS} = 0\text{ V}, I_D = 100\text{ mA}$	$V_{(BR)DSS}$	65	—	—	Volts
Zero Gate Voltage Drain Current	$V_{DS} = 28\text{ V}, V_{GS} = 0\text{ V}$	$I_{DSS}$	—	—	5.0	mA
Gate Threshold Voltage	$V_{DS} = 10\text{ V}, I_D = 150\text{ mA}$	$V_{GS(th)}$	3.0	—	5.0	Volts
Forward Transconductance	$V_{DS} = 10\text{ V}, I_D = 2\text{ A}$	$g_{fs}$	—	1.0	—	Siemens

## Maximum Ratings

Parameter	Symbol	Value	Unit
Drain-Source Voltage	$V_{DSS}$	65	Vdc
Gate-Source Voltage	$V_{GS}$	$\pm 20$	Vdc
Operating Junction Temperature	$T_J$	200	$^{\circ}\text{C}$
Total Device Dissipation at Above $25^{\circ}\text{C}$ derate by	$P_D$	365 2.08	Watts $\text{W}/^{\circ}\text{C}$
Storage Temperature Range	$T_{STG}$	$-40$ to $+150$	$^{\circ}\text{C}$
Thermal Resistance ( $T_{CASE} = 70^{\circ}\text{C}$ )	$R_{\theta JC}$	0.48	$^{\circ}\text{C}/\text{W}$

## Typical Performance

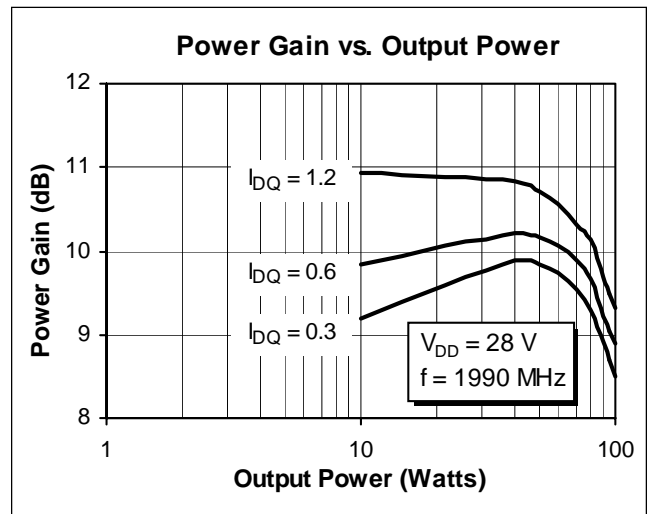
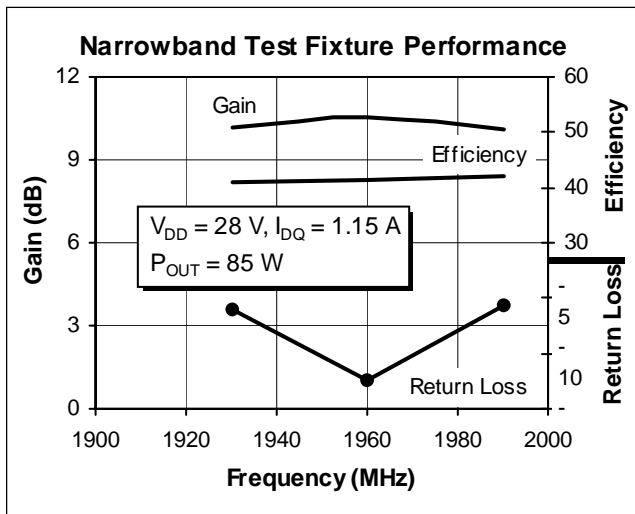

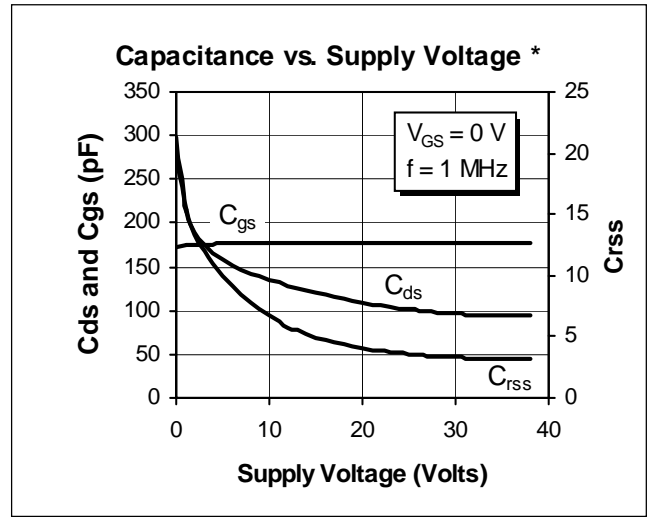
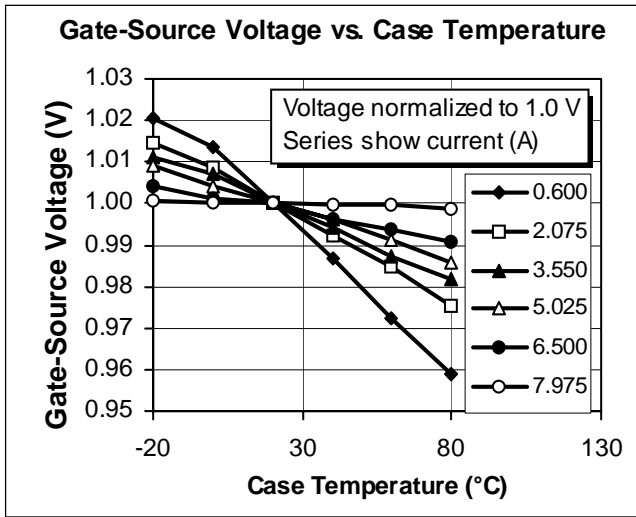

\* This part is internally matched. Measurements of the finished product will not yield these results.

**Impedance Data**

$V_{DD} = 28 \text{ V}$ ,  $P_{OUT} = 85 \text{ W}$ ,  $I_{DQ} = 1.15 \text{ A}$

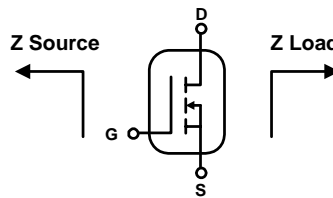

Frequency	Z Source $\Omega$		Z Load $\Omega$	
	R	jX	R	jX
1930	2.9	3.0	1.4	-0.2
1960	2.5	2.6	1.4	-0.9
1990	2.1	1.2	1.4	-1.5

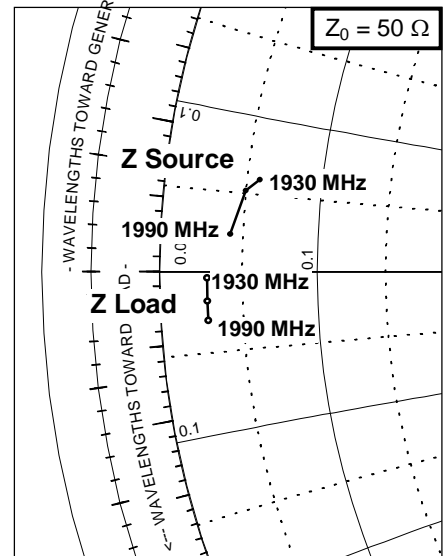

## Test Circuit

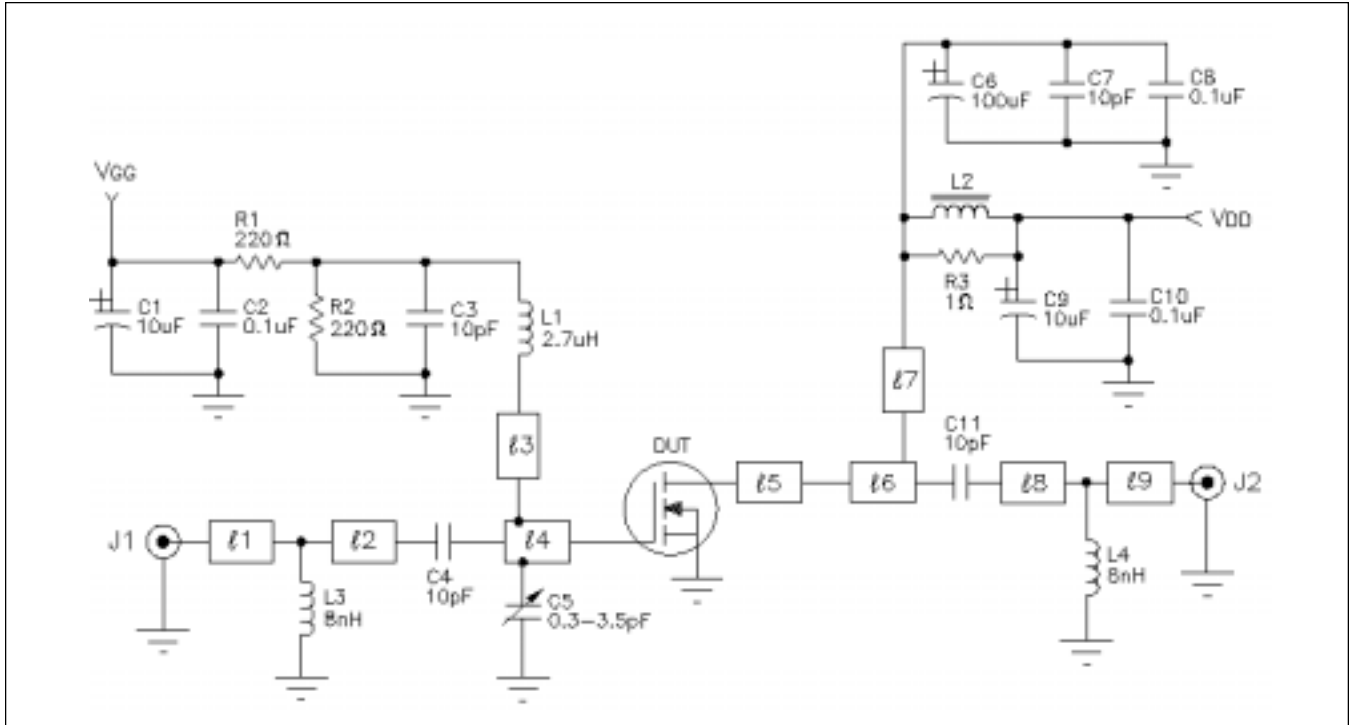

Test Circuit Block Diagram for  $f = 1.93\text{--}1.99\text{ GHz}$

Q1	PTF 10154	LDMOS RF Transistor
	1.96 GHz	IPM (OHMS)
l1	0.105 λ	1.96 GHz Microstrip 50 Ω
l2	0.119 λ	1.96 GHz Microstrip 50 Ω
l3	0.073 λ	1.96 GHz Microstrip 76.64 Ω
l4	0.094 λ	1.96 GHz Microstrip 9.73 Ω
l5	0.126 λ	1.96 GHz Microstrip 6.67 Ω
l6	0.614 λ	1.96 GHz Microstrip 9.62 Ω
l7	0.170 λ	1.96 GHz Microstrip 64.30 Ω
l8	0.050 λ	1.96 GHz Microstrip 50 Ω
l9	0.073 λ	1.96 GHz Microstrip 50 Ω
C1, C9	Capacitor, 10μF Digi-Key pcs 6106	
C2, C10	Capacitor, 0.1μF, 50V Digi-Key PCC103BCT	
C3, C4, C7, C11	Capacitor, 10pF ATC 100 b	
C5	Capacitor, variable 0.3–3.5pF JACO johanson 5801	
C6	Capacitor, 100μF, 50V Digi-Key P5182-ND	
C8	Capacitor, 0.1μF, 50V Digi-Key P4525-ND	
J1, J2	Connector, SMA female, panel mount 1301-rpm 513 412/53	
L1	Chip inductor, 2.7μH	
L2	Ferrite, 6mm phillips 53/3/4.6-452	
L3, L4	Inductor, 8nH coilcraft 0805CS-080 jbc	
R1, R2	Resistor, 220 ohm Digi-Key 220 qbk	
R3	Resistor, 1 ohm DIGI-KEY 1.0 qbk	
Circuit Board	0.050", 2 OZ Copper rogers corporation, TMM6	

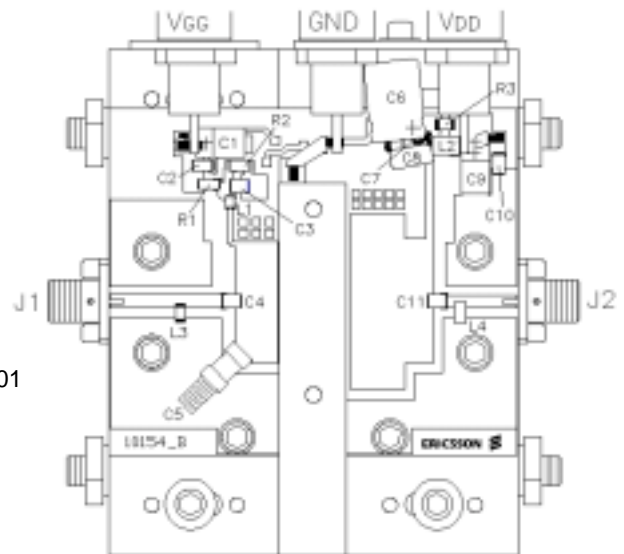

Parts Layout (not to scale)

**Package Mechanical Specifications**

